

ELECTRONIC MONITOR WHEEL BALANCER

AUTOMATIC WHEEL BALANCER

The **Librak360PWS Pro** brings the optimal support for wheel balancing with its improved weight tray, tape-weight roller support and 22-inch screen.

Thanks to the automatic program sequence and hidden weight

program to place the weight behind the spokes, it allows fast, precise and aesthetic balancing of passenger car tires up to a 30" diameter.

+ Error proof: automatic wheel data acquisition and laser blade
+ Intuitive software: PC board with self-explaining interface
+ All-in-one capacity: wide weight tray and dedicated storage space for tools



Intuitive software design with self-explaining graphics

22" monitor (foil keyboard)

Programs: ALU-S, DYN, STATIC, SPLIT, SPOKE

PC board with improved serviceability and plug&play connectors

Redesigned, wider weight tray for unlimited storage options and easy organization of tools, weights and accessories

Automatic start by lowering the wheel guard

The machine automatically stops the wheel in the outside unbalance position

Quickly operational thanks to automatic program sequence and automatic locking in position of the outer counterweight

Automatic measurement of distance and diameter by integrated 2D measuring arm with increased length

Wide and sturdy chassis

HIGHLIGHTS IN DETAIL

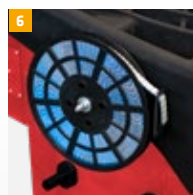
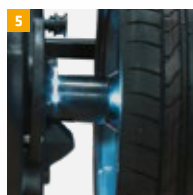
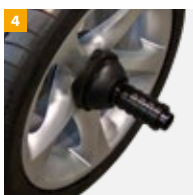
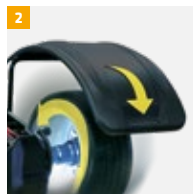

1 Indicates the weight positioning with a laser line at 6 o'clock (for adhesive weights).

2 Automatic start when the wheel guard is lowered. The machine automatically stops the wheel in the outer unbalance position and automatically rotates to the inner unbalance position at the push of a button.

3 Sonar for automatic wheel width measurement.

4 Electronic wheel balancer with pneumatic clamping device.

5 LED light.

6 Tape-weight roller support.

ACCESSORIES ON REQUEST

- + Standard wheel lifter for Librak with or without weight compensation.
- + Various type flanges, cones, centring sleeves, etc.
- + Compatible printer kit and much more.

LIBRAK360PWS Pro

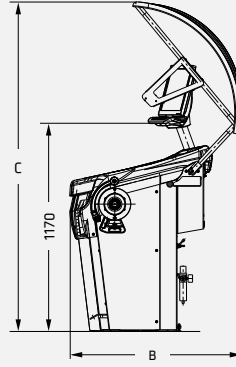
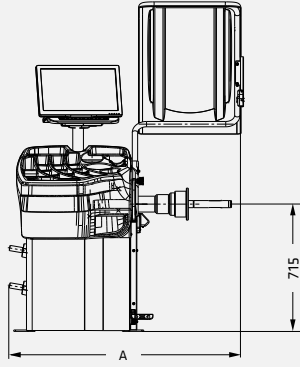

Model	LIBRAK360PWS Pro
Measuring speed	< 100 rpm
Measuring time	6 s
Balancing accuracy +/-	1 g
Display	LCD
Rim width	1,5" - 22"
Rim diameter min.	10" - 30"
Wheel diameter max.	1092 mm
Wheel weight max.	70 kg
Power supply	230 V 50 - 60 Hz
Phases	1
B Depth	963 mm
A Width	1347 mm
C Height	1850 mm
Weight	145 kg
Article Number (RAL3002)	812792
Article Number (RAL7016)	812793

SCOPE OF DELIVERY

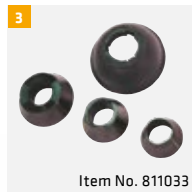
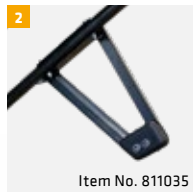
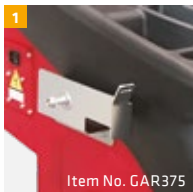

- 1 Tape-weight roller support
- 2 Sonar for width acquisition
- 3 Passenger car cone set Ø 44 - 112 mm
- 4 SUV cone Ø 95 - 132 mm

